



SANYO Semiconductors

DATA SHEET

MCH6429

N-Channel Silicon MOSFET

General-Purpose Switching Device Applications

Features

- Low ON-resistance.
- Ultrahigh-speed switching.
- 1.8V drive.

Specifications

Absolute Maximum Ratings at $T_a=25^\circ\text{C}$

Parameter	Symbol	Conditions	Ratings	Unit
Drain-to-Source Voltage	V_{DS}		20	V
Gate-to-Source Voltage	V_{GS}		± 12	V
Drain Current (DC)	I_D		6	A
Drain Current (Pulse)	I_{DP}	$PW \leq 10\mu\text{s}$, duty cycle $\leq 1\%$	24	A
Allowable Power Dissipation	P_D	Mounted on a ceramic board (900mm ² ×0.8mm)	1.5	W
Channel Temperature	T_{ch}		150	$^\circ\text{C}$
Storage Temperature	T_{stg}		-55 to +150	$^\circ\text{C}$

Electrical Characteristics at $T_a=25^\circ\text{C}$

Parameter	Symbol	Conditions	Ratings			Unit
			min	typ	max	
Drain-to-Source Breakdown Voltage	$V_{(BR)DSS}$	$I_D=1\text{mA}$, $V_{GS}=0\text{V}$	20			V
Zero-Gate Voltage Drain Current	I_{DSS}	$V_{DS}=20\text{V}$, $V_{GS}=0\text{V}$			1	μA
Gate-to-Source Leakage Current	I_{GSS}	$V_{GS}=\pm 8\text{V}$, $V_{DS}=0\text{V}$			± 10	μA
Cutoff Voltage	$V_{GS(off)}$	$V_{DS}=10\text{V}$, $I_D=1\text{mA}$	0.4		1.3	V
Forward Transfer Admittance	$ y_{fs} $	$V_{DS}=10\text{V}$, $I_D=3\text{A}$	3.8	6.4		S
Static Drain-to-Source On-State Resistance	$R_{DS(on)1}$	$I_D=3\text{A}$, $V_{GS}=4\text{V}$		21	28	$\text{m}\Omega$
	$R_{DS(on)2}$	$I_D=1.5\text{A}$, $V_{GS}=2.5\text{V}$		27	38	$\text{m}\Omega$
	$R_{DS(on)3}$	$I_D=1\text{A}$, $V_{GS}=1.8\text{V}$		38	76	$\text{m}\Omega$

Marking : ZD

Continued on next page.

■ Any and all SANYO Semiconductor Co.,Ltd. products described or contained herein are, with regard to "standard application", intended for the use as general electronics equipment (home appliances, AV equipment, communication device, office equipment, industrial equipment etc.). The products mentioned herein shall not be intended for use for any "special application" (medical equipment whose purpose is to sustain life, aerospace instrument, nuclear control device, burning appliances, transportation machine, traffic signal system, safety equipment etc.) that shall require extremely high level of reliability and can directly threaten human lives in case of failure or malfunction of the product or may cause harm to human bodies, nor shall they grant any guarantee thereof. If you should intend to use our products for applications outside the standard applications of our customer who is considering such use and/or outside the scope of our intended standard applications, please consult with us prior to the intended use. If there is no consultation or inquiry before the intended use, our customer shall be solely responsible for the use.

■ Specifications of any and all SANYO Semiconductor Co.,Ltd. products described or contained herein stipulate the performance, characteristics, and functions of the described products in the independent state, and are not guarantees of the performance, characteristics, and functions of the described products as mounted in the customer's products or equipment. To verify symptoms and states that cannot be evaluated in an independent device, the customer should always evaluate and test devices mounted in the customer's products or equipment.

SANYO Semiconductor Co., Ltd.

TOKYO OFFICE Tokyo Bldg., 1-10, 1 Chome, Ueno, Taito-ku, TOKYO, 110-8534 JAPAN

MCH6429

Continued from preceding page.

Parameter	Symbol	Conditions	Ratings			Unit
			min	typ	max	
Input Capacitance	C_{iss}	$V_{DS}=10V, f=1MHz$		680		pF
Output Capacitance	C_{oss}	$V_{DS}=10V, f=1MHz$		175		pF
Reverse Transfer Capacitance	C_{rss}	$V_{DS}=10V, f=1MHz$		135		pF
Turn-ON Delay Time	$t_{d(on)}$	See specified Test Circuit.		13		ns
Rise Time	t_r	See specified Test Circuit.		90		ns
Turn-OFF Delay Time	$t_{d(off)}$	See specified Test Circuit.		57		ns
Fall Time	t_f	See specified Test Circuit.		91		ns
Total Gate Charge	Q_g	$V_{DS}=10V, V_{GS}=4V, I_D=6A$		8.2		nC
Gate-to-Source Charge	Q_{gs}	$V_{DS}=10V, V_{GS}=4V, I_D=6A$		1.45		nC
Gate-to-Drain "Miller" Charge	Q_{gd}	$V_{DS}=10V, V_{GS}=4V, I_D=6A$		2.7		nC
Diode Forward Voltage	V_{SD}	$I_S=6A, V_{GS}=0V$		0.8	1.2	V

Package Dimensions

unit : mm (typ)

7022A-009

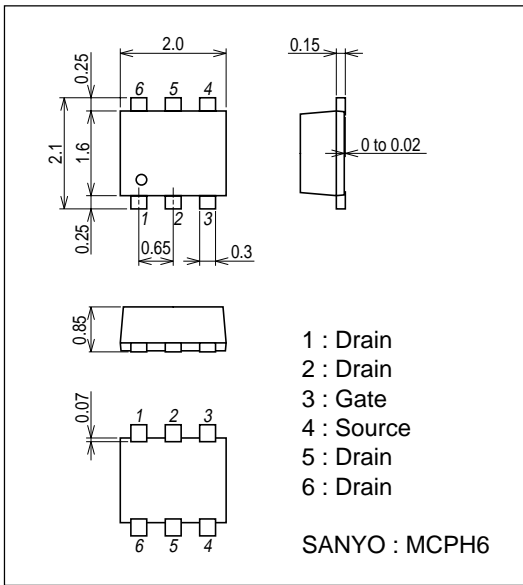

Switching Time Test Circuit

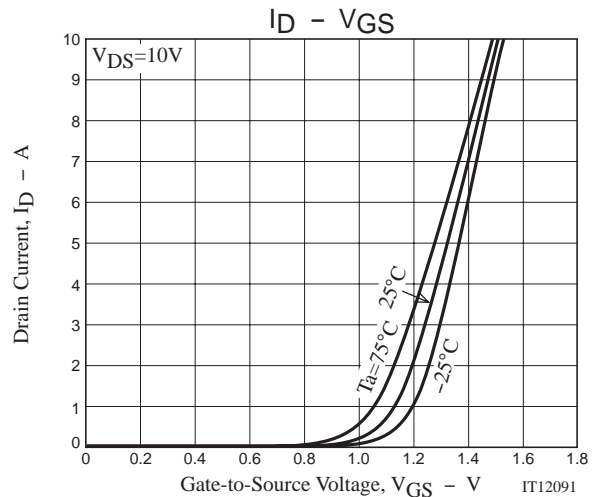
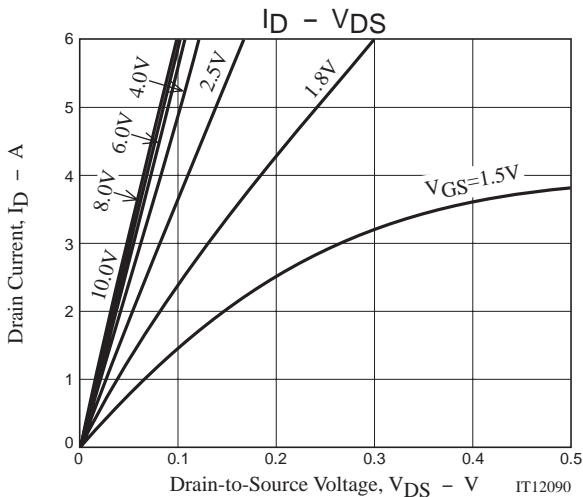
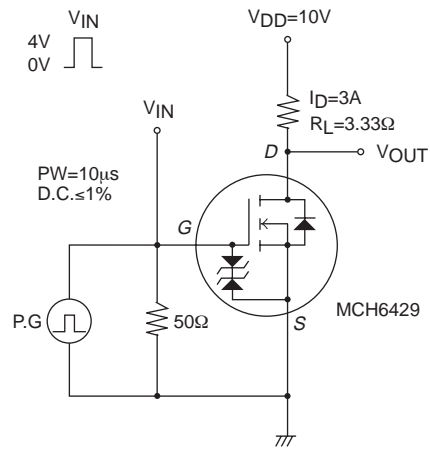

MCH6429

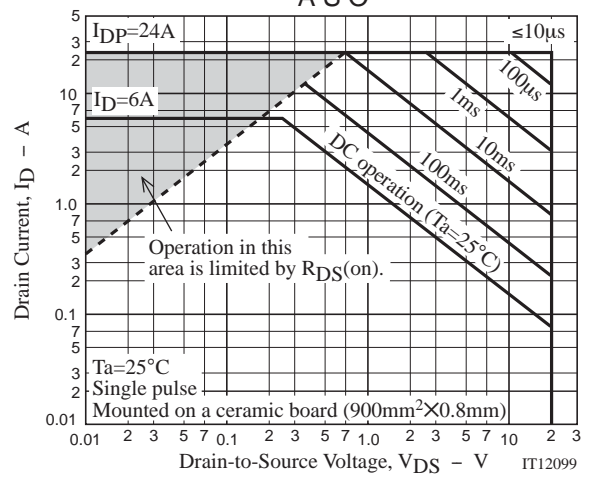
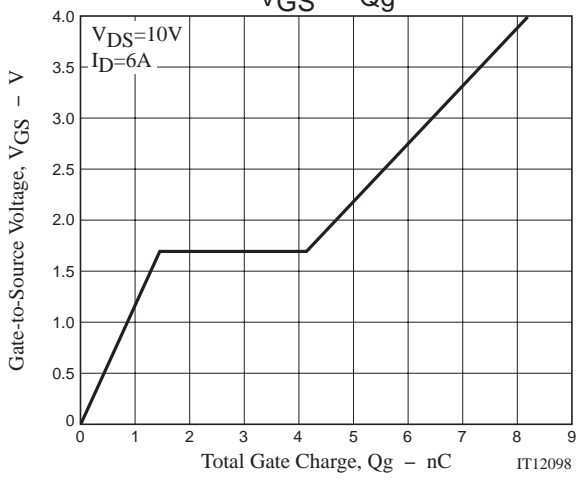
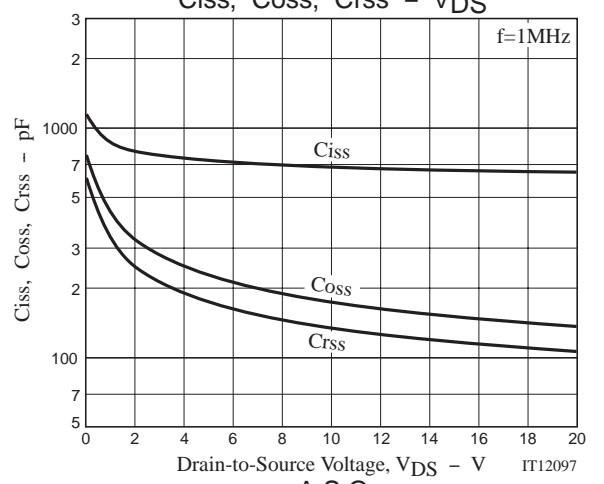
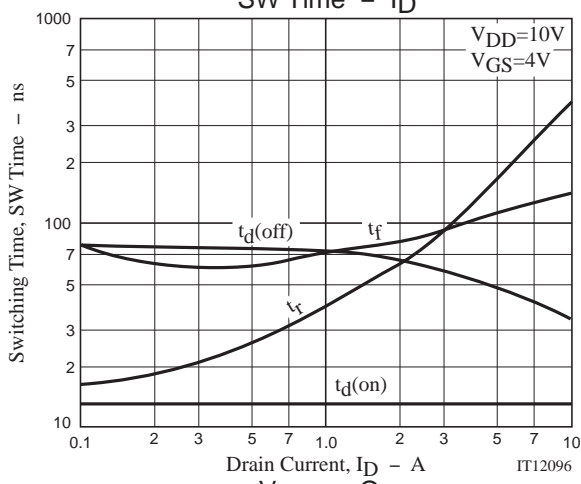
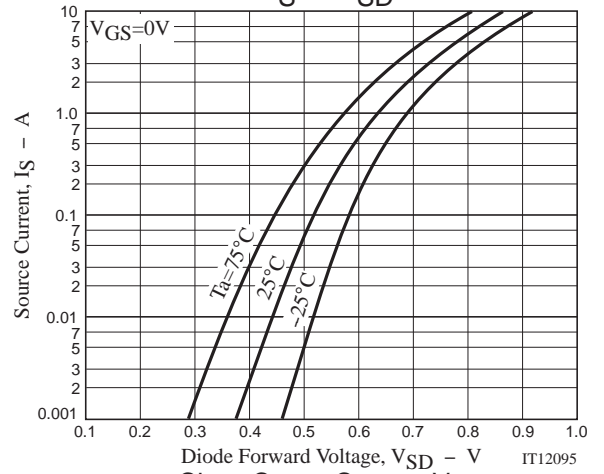
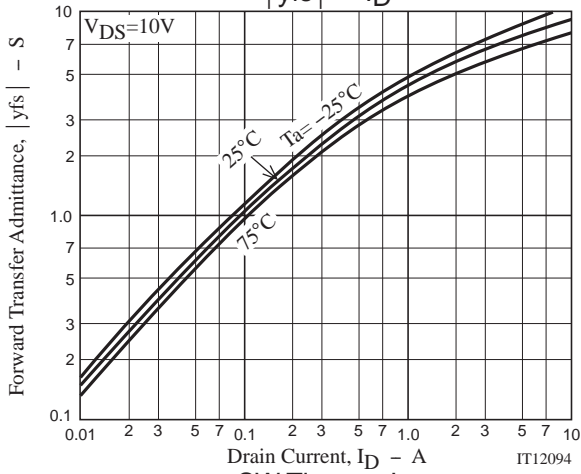
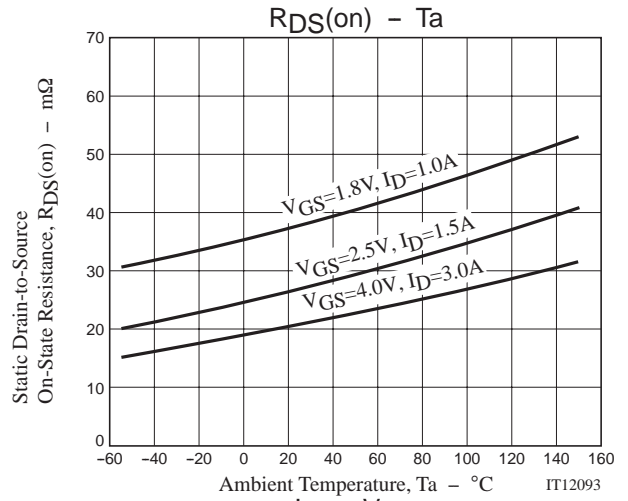
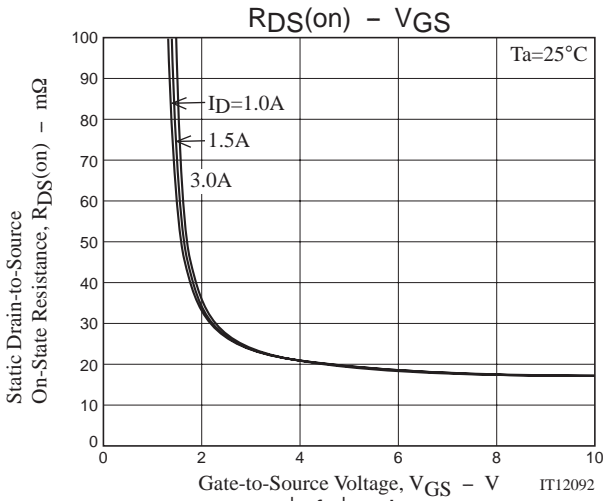

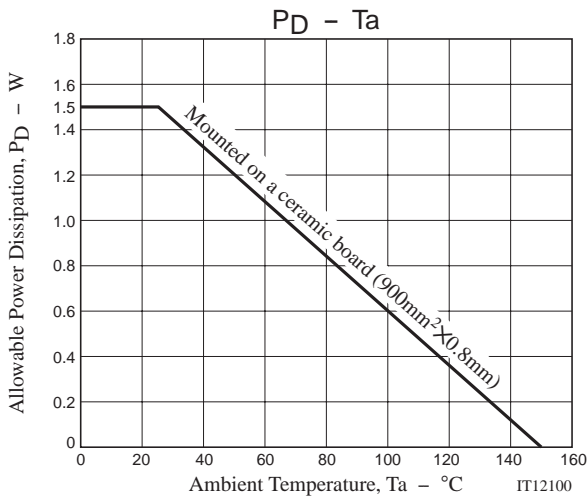

Note on usage : Since the MCH6429 is a MOSFET product, please avoid using this device in the vicinity of highly charged objects.

- SANYO Semiconductor Co.,Ltd. assumes no responsibility for equipment failures that result from using products at values that exceed, even momentarily, rated values (such as maximum ratings, operating condition ranges, or other parameters) listed in products specifications of any and all SANYO Semiconductor Co.,Ltd. products described or contained herein.
- SANYO Semiconductor Co.,Ltd. strives to supply high-quality high-reliability products, however, any and all semiconductor products fail or malfunction with some probability. It is possible that these probabilistic failures or malfunction could give rise to accidents or events that could endanger human lives, trouble that could give rise to smoke or fire, or accidents that could cause damage to other property. When designing equipment, adopt safety measures so that these kinds of accidents or events cannot occur. Such measures include but are not limited to protective circuits and error prevention circuits for safe design, redundant design, and structural design.
- In the event that any or all SANYO Semiconductor Co.,Ltd. products described or contained herein are controlled under any of applicable local export control laws and regulations, such products may require the export license from the authorities concerned in accordance with the above law.
- No part of this publication may be reproduced or transmitted in any form or by any means, electronic or mechanical, including photocopying and recording, or any information storage or retrieval system, or otherwise, without the prior written consent of SANYO Semiconductor Co.,Ltd.
- Any and all information described or contained herein are subject to change without notice due to product/technology improvement, etc. When designing equipment, refer to the "Delivery Specification" for the SANYO Semiconductor Co.,Ltd. product that you intend to use.
- Information (including circuit diagrams and circuit parameters) herein is for example only; it is not guaranteed for volume production.
- Upon using the technical information or products described herein, neither warranty nor license shall be granted with regard to intellectual property rights or any other rights of SANYO Semiconductor Co.,Ltd. or any third party. SANYO Semiconductor Co.,Ltd. shall not be liable for any claim or suits with regard to a third party's intellectual property rights which has resulted from the use of the technical information and products mentioned above.

This catalog provides information as of February, 2007. Specifications and information herein are subject to change without notice.